

Features

- Universal input 85-265VAC
- High Efficiency Rating up to 89%
- Operating ambient temperature range: -40°C to +85°C
- Approved to UKCA, CE, CB, cURus, FCC, RoHS & REACH
- EN/IEC/UL 62368-1 Safety Approved
- Output Voltage 3.3 - 53VDC

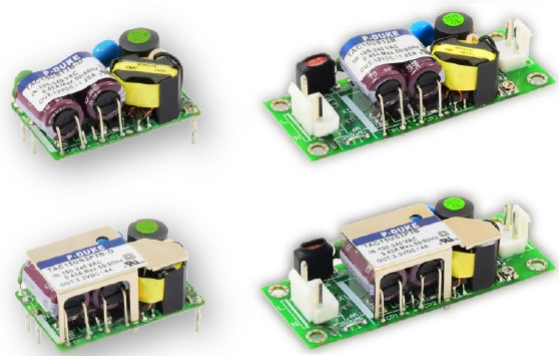

Ideal Power's 43TAC15-USxy 15W Open Frame Chassis AC/DC Power Supply Module Series are certified to cURus, UKCA, CE, FCC, CB, RoHS, REACH & EN 62368-1/IEC 62368-1/UL 62368-1 Standards and comply with the relevant Efficiency Regulations. These are primarily used in ITE, Audio & Video Industries and customised solutions are available upon request.

Part Number Structure

TAC15 - U S 12 A - □ □

Series Name	Input Voltage (V AC)	Output Quantity	Output Voltage (V DC)	Protection Type	Connector Options	Conformal Coating Options
	85 ~ 264	S: Single	3P3: 3.3 05: 5 7P5: 7.5 09: 9 12: 12 15: 15 18: 18 24: 24 28: 28 36: 36 48: 48 53: 53	□ : CLASS I B: CLASS II	□: JST M: Molex T: Terminal Block D: Pin Type* *(only for CLASS II)	□ : None R: Conformal Coating *Only pin type (-D) has trim function

Models

Model Number	Input Range	Output Voltage	Output Current Natural Convection	Max Output Power	Input Power @ No Load	Efficiency	Maximum Capacitor Load
	V AC	V DC	A	W	W	%	µF
36TAC15US3P3B	85 ~ 264	3.3	4000	13.2	25	84	6000
36TAC15US05B	85 ~ 264	5	3000	15	25	86	4000
36TAC15US7P5B	85 ~ 264	7.5	2000	15	25	86	3000
36TAC15US09B	85 ~ 264	9	1670	15	25	86	1860
36TAC15US12B	85 ~ 264	12	1250	15	35	87	1200
36TAC15US15B	85 ~ 264	15	1000	15	35	87	820
36TAC15US18B	85 ~ 264	18	834	15	35	87	560
36TAC15US24B	85 ~ 264	24	625	15	35	88	470
36TAC15US28B	85 ~ 264	28	536	15	35	88	330
36TAC15US36B	85 ~ 264	36	417	15	35	88	220
36TAC15US48B	85 ~ 264	48	313	15	50	88.5	150
36TAC15US53B	85 ~ 264	53	284	15	50	89	82

Input Specifications

Parameter	Conditions	Min	Typ	Max	Unit
Operating input voltage range	AC input	85		264	VAC
	DC input	120		370	VDC
Input frequency	AC input	47		63	Hz
Input current	100VAC and Full Load			0.45	A
	240VAC and Full Load			0.30	
No load input power	230VAC	3.3Vout to 9Vout		25	W
		12Vout to 36Vout		35	
		48Vout to 53Vout		50	
Leakage current	264VAC			75	µA
Start up time				500	ms
Rise time			20		ms
Hold up time	115VAC and Full Load		8		ms
Input inrush current	230VAC		40		A
Input protection	Internal fuse			T4.0A/250VAC	

Output Specifications

Parameter	Conditions	Min	Typ	Max	Unit
Output power				15	
Initial set voltage accuracy	230VAC and Full Load	-1.0		+1.0	
Line regulation	Low Line to High Line at Full Load	-0.2		+0.2	
Load regulation	No Load to Full Load	3.3Vout, 5Vout		+0.7	W
		Others		+0.5	
	10% Load to 90% Load	3.3Vout, 5Vout		+0.6	
		Others		+0.4	
Voltage adjustability		-10		+10	
Minimum load			0		
Ripple and noise	Measured by 20MHz bandwidth With a 1μF/50V 1206 X7R MLCC	3.3Vout, 5Vout		40	mVp-p
		7.5Vout, 9Vout, 12Vout, 15Vout		70	
		18Vout, 24Vout, 28Vout, 36Vout		100	
		48Vout, 53Vout		140	
	With a 0.1μF/100V 1206 X7R MLCC				
Temperature coefficient		-0.02		+0.02	%/°C
Transient response	Load step from 75 ~ 100% change at 2.5A/μs	Peak deviation		5	% Vout
		Recovery time		500	μs
Over voltage protection	% Of Vout(nom); Latch mode	125		140	%
Overload protection	% Of maximum Iout rated; Hiccup mode			145	%
Short circuit protection					Continuous, automatic recovery

General Specifications

Parameter	Conditions	Min	Typ	Max	Unit
Isolation voltage	1 minute (reinforced insulation) Input to Output	3000			V AC
Isolation resistance	500V DC	0.1			GΩ
Switching frequency	230VAC, Full load		170		kHz
Safety approvals	IEC/ EN/ UL 62368-1				UL:E193009 CB:UL(Demko)
Weight	Connector Type				19.0g (0.67oz)
	Pin Type				16.5g (0.58oz)
MTBF	MIL-HDBK-217F Ta=25°C, Full load				3.063 x 10 ⁵ hrs

Environmental Specifications

Parameter	Conditions	Min	Typ	Max	Unit
Operating ambient temperature	Natural convection	-40		+85	°C
Storage temperature range		-40		+85	°C
Operating altitude				5000	m
Shock					IEC60068-2-27
Vibration					IEC60068-2-6
Relative humidity	Non-condensing				5% to 95% RH

EMC Specifications

Parameter	Conditions		Level	
EMI	EN55032 and FCC Part 15		Conducted	Class B
			Radiated	Class B
Harmonic currents	EN61000-3-2	Full Load	Class A	
Voltage flicker	EN61000-3-3			
EMS	EN55024			
ESD	EN61000-4-2		Perf. Criteria A	
Radiated immunity	EN61000-4-3	20 V/m	Perf. Criteria A	
Fast transient	EN61000-4-4	± 2kV	Perf. Criteria A	
Surge	EN61000-4-5	DM ± 1kV	Perf. Criteria A	
Conducted immunity	EN61000-4-6	20 Vr.m.s	Perf. Criteria A	
Power frequency magnetic field	EN61000-4-8	30A/m	Perf. Criteria A	
Dip and interruptions	EN61000-4-11			

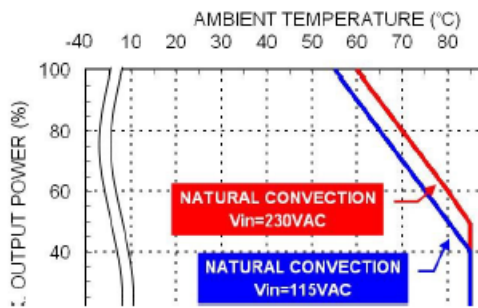
Characteristic Curve

Derating Curve vs. Ambient Temperature
 TAC15USxxB xx=3P3/05/7P5/09/12/15/18
 Connector Option : (□: JST)

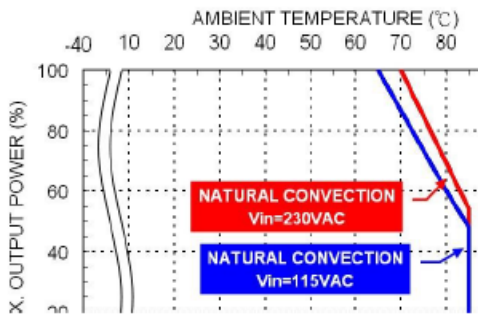

Derating Curve vs. Ambient Temperature
 TAC15USxxB xx=24/28/36/48/53
 Connector Option : (□: JST)

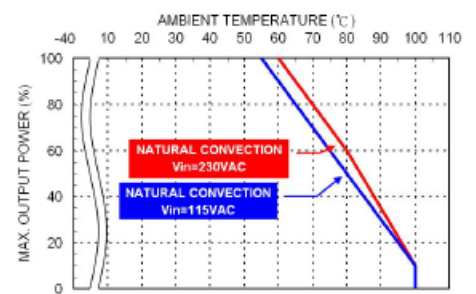

Derating Curve vs. Ambient Temperature
 TAC15USxxB xx=3P3/05/7P5/09/12/15/18
 Connector Option : (-M / -T / -D)

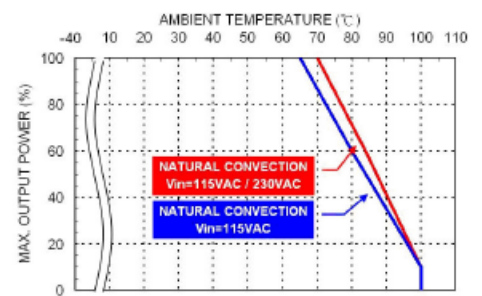

Derating Curve vs. Ambient Temperature
 TAC15USxxB xx=24/28/36/48/53
 Connector Option : (-M / -T / -D)

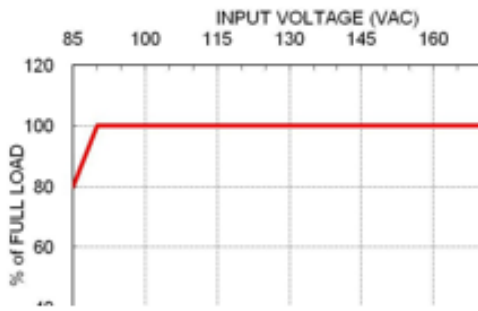
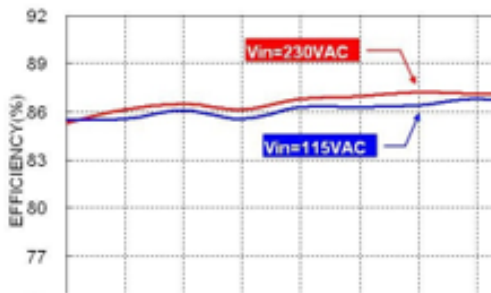
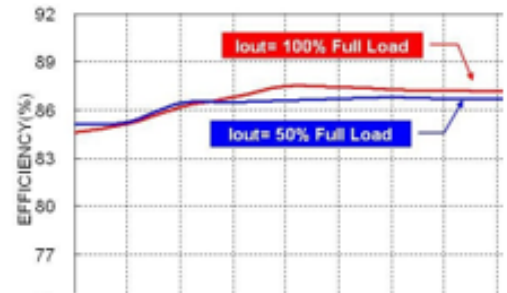
Characteristic Curve (continued)

Derating Curve vs. Input Voltage

43TAC15US12B Efficiency vs. Output Load

43TAC15US12B Efficiency vs. Input Voltage

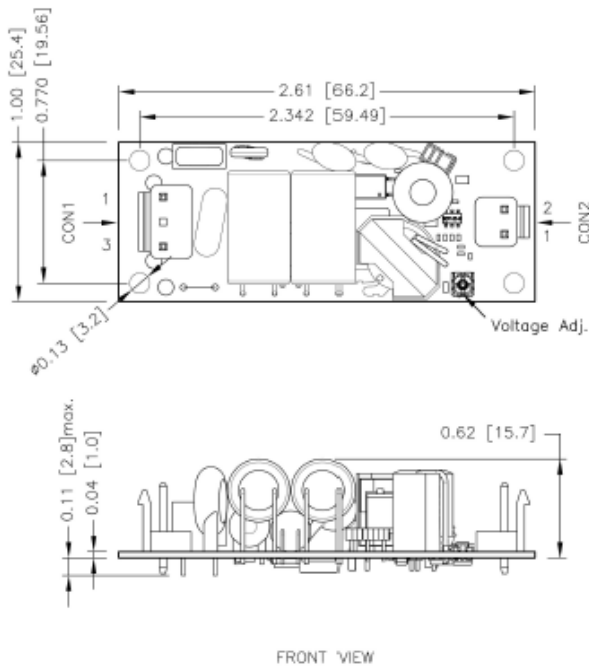
Mechanical Drawing

43TAC Connector Type

*Either one of four screw holes of Open / Chassis type can be considered as PE connection for CLASS I application



43TAC Connector type with heat-sink assembly (For 3.3Vout, 5Vout, 9Vout)

*Either one of four screw holes of Open / Chassis type can be considered as PE connection for CLASS I application.

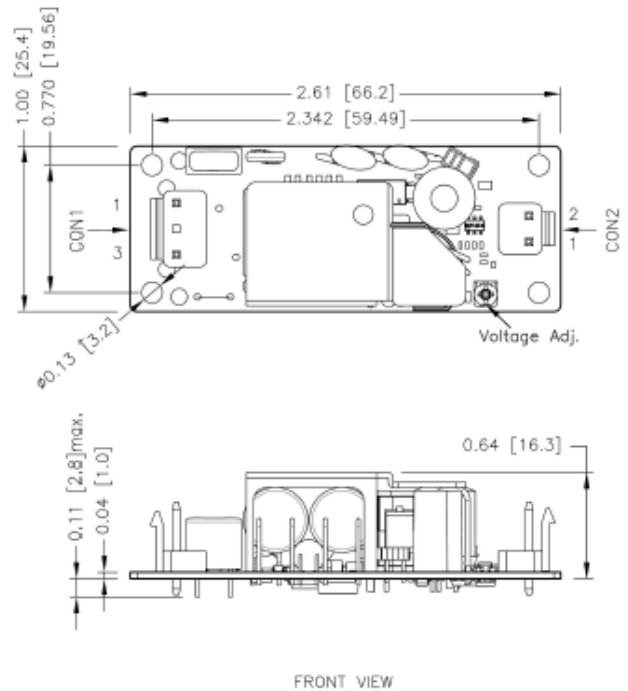

- All dimensions in inch [mm]
Tolerance : $x.xx \pm 0.02$ [$x.x \pm 0.5$]
 $x.xxx \pm 0.010$ [$x.xx \pm 0.25$]
- The screw locked torque: MAX 5.0kgf-cm/0.49N-m

CON1-Input Connector

Pin 1	Line
Pin 3	Neutral

CON2-Output Connector

Pin 1	-Vout
Pin 2	+Vout

Connector Options

Blank:

JST Type

Housing

CON1: VHR-3N

CON2: VHR-2N

Crimp terminals

CON1: SVH-21T-P1.1

CON2: SVH-21T-P1.1



-M

Molex Type

Housing

CON1: 09-50-8031

CON2: 09-50-8021

Crimp terminals

CON1: SD-2478

CON2: SD-2478



-T

Terminal Block

Mates with

Screw locked torque
MAX 2Kgf.cm/0.2N.m

Wire dimension range
26 ~ 16AWG



Ideal Power Limited

14 Larks Way, Tree Beech Enterprise Park, Gunn, Barnstaple, Devon, England, EX32 7NZ.

www.idealpower.co.uk | +44 (0) 845 260 3400

Page 6 of 11

Mechanical Drawing

43TAC-D Pin Type

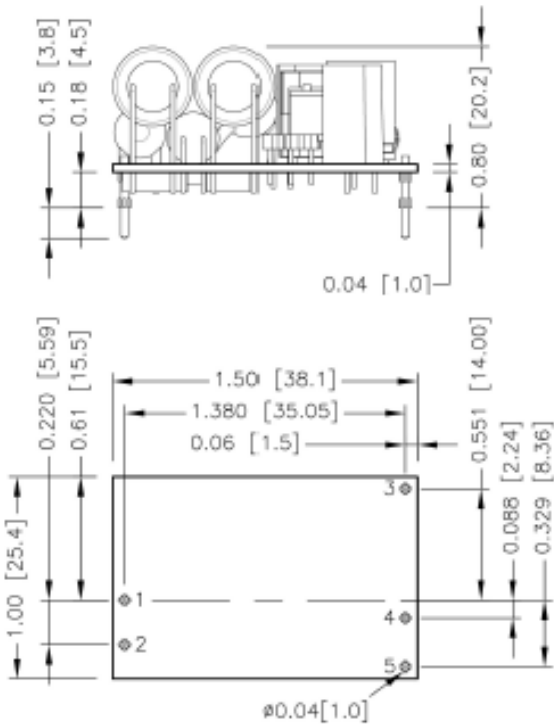

BOTTOM VIEW

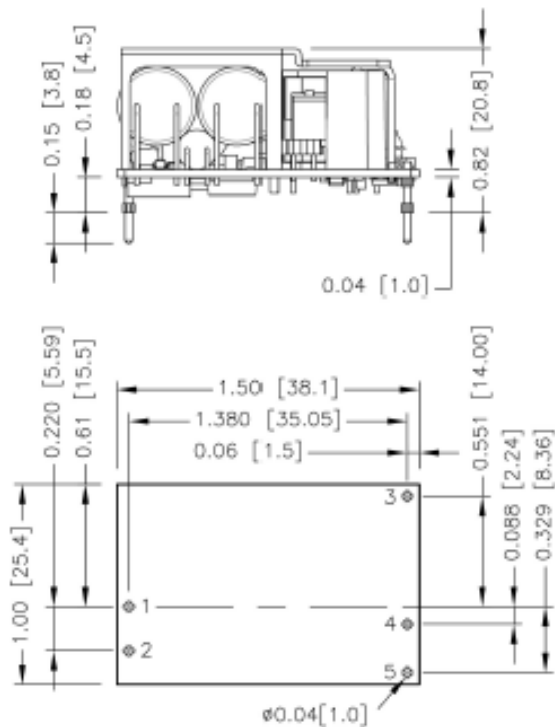
 43TAC-D Pin type with heat-sink assembly
 (For 3.3Vout, 5Vout, 9Vout)

BOTTOM VIEW

1. All dimensions in inch [mm]
 Tolerance :x.xx±0.02 [x.x±0.5]
 x.xxx±0.010 [x.xx±0.25]
2. Pin pitch tolerance ±0.010 [0.25]
3. Pin dimension tolerance ±0.004[0.10]

Pin Connection

PIN	SINGLE
1	Neutral
2	Line
3	Trim
4	-Vout
5	+Vout

Recommended PAD Layout

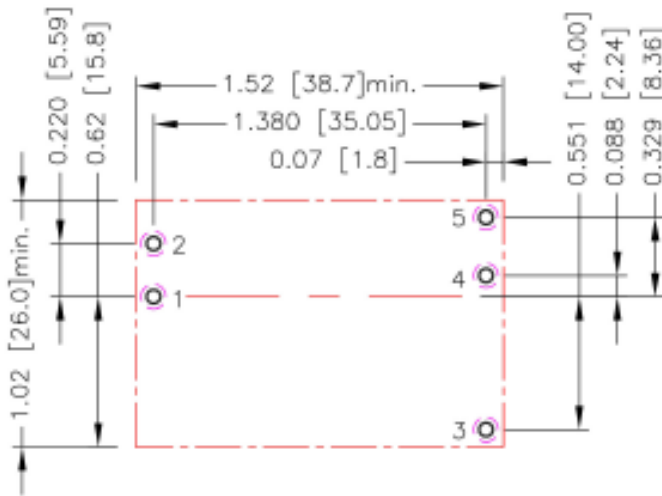

All dimensions in inch[mm]
 Pad size(lead free recommended)
 Through hole 1.2.3.4.5: $\Phi 0.051$ [1.30]
 Top view pad 1.2.3.4.5: $\Phi 0.064$ [1.63]
 Bottom view pad 1.2.3.4.5: $\Phi 0.102$ [2.60]

Output Voltage Adjustment

It allows the user to increase or decrease the output voltage of the module. This is accomplished by connecting an external resistor between the Trim pin and either the +Vout or -Vout pins. With an external resistor between the Trim and -Output pin, the output voltage increases. With an external resistor between the Trim and +Output pin, the output voltage decrease. The external Trim resistor needs to be at least 1/16W of rated power.

■ Trim Constants

■ Trim Up Equation

$$R_U = \left[\frac{G \times L}{(V_{o,up} - L - K)} - H \right] \Omega$$

■ Trim Down Equation

$$R_D = \left[\frac{(V_{o,down} - L) \times G}{(V_o - V_{o,down})} - H \right] \Omega$$

Module	G	H	K	L
36TAC15US3P3B-D	2000	2000	0.8	2.5
36TAC15US05B-D	7500	2000	2.5	2.5
36TAC15US7P5B-D	22000	2000	5	2.5
36TAC15US09B-D	30000	2000	6.5	2.5
36TAC15US12B-D	51000	2000	9.5	2.5
36TAC15US15B-D	68000	2000	12.5	2.5
36TAC15US18B-D	91000	2000	15.5	2.5
36TAC15US24B-D	130000	2000	21.5	2.5
36TAC15US28B-D	150000	2000	25.5	2.5
36TAC15US36B-D	200000	2000	33.5	2.5
36TAC15US48B-D	270000	2000	45.5	2.5
36TAC15US53B-D	270000	2000	50.5	2.5

Trim Up
EXTERNAL OUTPUT TRIMMING

Output can be externally trimmed by using the method shown below.

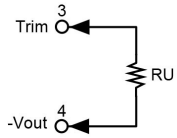
US3P3B-D

ΔV (%)	1	2	3	4	5	6	7	8	9	10
Vout (V)	3.333	3.366	3.399	3.432	3.465	3.498	3.531	3.564	3.597	3.630
RU (k Ω)	149.515	73.758	48.505	35.879	28.303	23.253	19.645	16.939	14.835	13.152

US05B-D

ΔV (%)	1	2	3	4	5	6	7	8	9	10
Vout (V)	5.050	5.100	5.150	5.200	5.250	5.300	5.350	5.400	5.450	5.500
RU (k Ω)	373.000	185.500	123.000	91.750	73.000	60.500	51.571	44.875	39.667	35.500

US7P5B-D

ΔV (%)	1	2	3	4	5	6	7	8	9	10
Vout (V)	7.575	7.650	7.725	7.800	7.875	7.950	8.025	8.100	8.175	8.250
RU (k Ω)	731.333	364.667	242.444	181.333	144.667	120.222	102.762	89.667	79.481	71.333

US09B-D

ΔV (%)	1	2	3	4	5	6	7	8	9	10
Vout (V)	9.090	9.180	9.270	9.360	9.450	9.540	9.630	9.720	9.810	9.900
RU (k Ω)	831.333	414.667	275.778	206.333	164.667	136.889	117.048	102.167	90.593	81.333

US12B-D

ΔV (%)	1	2	3	4	5	6	7	8	9	10
Vout (V)	12.120	12.240	12.360	12.480	12.600	12.720	12.840	12.960	13.080	13.200
RU (k Ω)	1060.500	529.250	352.167	263.625	210.500	175.083	149.786	130.813	116.056	104.250

US15B-D

ΔV (%)	1	2	3	4	5	6	7	8	9	10
Vout (V)	15.150	15.300	15.450	15.600	15.750	15.900	16.050	16.200	16.350	16.500
RU (k Ω)	1131.333	564.667	375.778	281.333	224.667	186.889	159.905	139.667	123.926	111.333

US18B-D

ΔV (%)	1	2	3	4	5	6	7	8	9	10
Vout (V)	18.180	18.360	18.540	18.720	18.900	19.080	19.260	19.440	19.620	19.800
RU (k Ω)	1261.889	629.944	419.296	313.972	250.778	208.648	178.556	155.986	138.432	124.389

US24B-D

ΔV (%)	1	2	3	4	5	6	7	8	9	10
Vout (V)	24.240	24.480	24.720	24.960	25.200	25.440	25.680	25.920	26.160	26.400
RU (k Ω)	1352.167	675.083	449.389	336.542	268.833	223.694	191.452	167.271	148.463	133.417

US28B-D

ΔV (%)	1	2	3	4	5	6	7	8	9	10
Vout (V)	28.280	28.560	28.840	29.120	29.400	29.680	29.960	30.240	30.520	30.800
RU (k Ω)	1337.286	667.643	444.429	332.821	265.857	221.214	189.327	165.411	146.810	131.929

US36B-D

ΔV (%)	1	2	3	4	5	6	7	8	9	10
Vout (V)	36.360	36.720	37.080	37.440	37.800	38.160	38.520	38.880	39.240	39.600
RU (k Ω)	1386.889	692.444	460.963	345.222	275.778	229.481	196.413	171.611	152.321	136.889

Trim Up (continued)

US48B-D										
ΔV (%)	1	2	3	4	5	6	7	8	9	10
Vout (V)	48.480	48.960	49.440	49.920	50.400	50.880	51.360	51.840	52.320	52.800
RU (k Ω)	1404.250	701.125	466.750	349.563	279.250	232.375	198.893	173.781	154.250	138.625
US53B-D										
ΔV (%)	1	2	3	4	5	6	7	8	9	10
Vout (V)	53.530	54.060	54.590	55.120	55.650	56.180	56.710	57.240	57.770	58.300
RU (k Ω)	1271.585	634.792	422.528	316.396	252.717	210.264	179.941	157.198	139.509	125.358

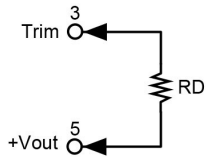
Trim Down

US3P3B-D

ΔV (%)	1	2	3	4	5	6	7	8	9	10
Vout (V)	3.267	3.234	3.201	3.168	3.135	3.102	3.069	3.036	3.003	2.970
RU (k Ω)	44.485	20.242	12.162	8.121	5.697	4.081	2.926	2.061	1.387	0.848

US05B-D

ΔV (%)	1	2	3	4	5	6	7	8	9	10
Vout (V)	4.950	4.900	4.850	4.800	4.750	4.700	4.650	4.600	4.550	4.500
RU (k Ω)	365.500	178.000	115.500	84.250	65.500	53.000	44.071	37.375	32.167	28.000

US7P5B-D

ΔV (%)	1	2	3	4	5	6	7	8	9	10
Vout (V)	7.425	7.350	7.275	7.200	7.125	7.050	6.975	6.900	6.825	6.750
RU (k Ω)	1442.667	709.333	464.889	342.667	269.333	220.444	185.524	159.333	138.963	122.667

US09B-D

ΔV (%)	1	2	3	4	5	6	7	8	9	10
Vout (V)	8.910	8.820	8.730	8.640	8.550	8.460	8.370	8.280	8.190	8.100
RU (k Ω)	2134.667	1051.333	690.222	509.667	401.333	329.111	277.524	238.833	208.741	184.667

US12B-D

ΔV (%)	1	2	3	4	5	6	7	8	9	10
Vout (V)	11.880	11.760	11.640	11.520	11.400	11.280	11.160	11.040	10.920	10.800
RU (k Ω)	3984.500	1965.750	1292.833	956.375	754.500	619.917	523.786	451.688	395.611	350.750

US15B-D

ΔV (%)	1	2	3	4	5	6	7	8	9	10
Vout (V)	14.850	14.700	14.550	14.400	14.250	14.100	13.950	13.800	13.650	13.500
RU (k Ω)	5596.667	2763.333	1818.889	1346.667	1063.333	874.444	739.524	638.333	559.630	496.667

US18B-D

ΔV (%)	1	2	3	4	5	6	7	8	9	10
Vout (V)	17.820	17.640	17.460	17.280	17.100	16.920	16.740	16.560	16.380	16.200
RU (k Ω)	7743.111	3825.056	2519.037	1866.028	1474.222	1213.019	1026.444	886.514	777.679	690.611

US24B-D

ΔV (%)	1	2	3	4	5	6	7	8	9	10
Vout (V)	23.760	23.520	23.280	23.040	22.800	22.560	22.320	22.080	21.840	21.600
RU (k Ω)	11513.833	5690.917	3749.944	2779.458	2197.167	1808.972	1531.690	1323.729	1161.981	1032.583

Trim Up (continued)

US28B-D										
ΔV (%)	1	2	3	4	5	6	7	8	9	10
Vout (V)	27.720	27.440	27.160	26.880	26.600	26.320	26.040	25.760	25.480	25.200
RU (k Ω)	13508.714	6678.357	4401.571	3263.179	2580.143	2124.786	1799.531	1555.589	1365.857	1214.071
US36B-D										
ΔV (%)	1	2	3	4	5	6	7	8	9	10
Vout (V)	35.640	35.280	34.920	34.560	34.200	33.840	33.480	33.120	32.760	32.400
RU (k Ω)	18409.111	9103.556	6001.704	4450.778	3520.222	2899.852	2456.730	2124.389	1865.901	1659.111
US48B-D										
ΔV (%)	1	2	3	4	5	6	7	8	9	10
Vout (V)	47.520	47.040	46.560	46.080	45.600	45.120	44.640	44.160	43.680	43.200
RU (k Ω)	25321.750	12524.875	8259.250	6126.437	4846.750	3993.625	3384.250	2927.219	2571.750	2287.375
US53B-D										
ΔV (%)	1	2	3	4	5	6	7	8	9	10
Vout (V)	52.470	51.940	51.410	50.880	50.350	49.820	49.290	48.760	48.230	47.700
RU (k Ω)	25454.415	12591.208	8303.472	6159.604	4873.283	4015.736	3403.202	2943.802	2586.491	2300.642